



Warm The Sole

Price List 2018

Underfloor Heating



Welcome

Welcome to the WTS underfloor heating price list, inside you will find information and prices on our range of ufh systems along with some useful information on areas to watch out for.

At WTS we have many years experience in designing and supplying heating systems and our commitment to quality and performance has led us to be known as one of the best design and supply companies in the underfloor heating market.

We believe in talking to our customers so please feel free to give us a call or drop us an email to discuss your requirements further.

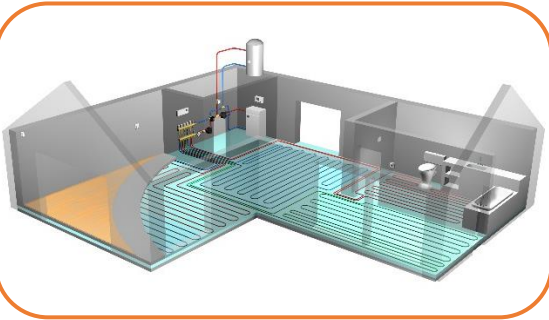

Design

Warm The Sole offers a full design service for your property, from heatloss calculations through CAD layout to optimising component choice to suit your project.

As with all projects there will be much in the way of changes to design, we can discuss your options throughout the lifetime of the project providing expert help and unrivalled advice from our knowledgeable design team. Any alterations can easily be accommodated, allowing you freedom to pursue your ideal design unhindered.

We provide a complete information pack with each design to assist all elements of the build, aiding the relevant tradesmen involved.

Quality

Quality never goes out of style goes the old adage. Something we rigorously adhere to at Warm The Sole.

We have deliberated with many manufacturers, finding a range of products that are incredible value, but more importantly, extraordinary quality. We have succeeded.

The underfloor heating kit is not the only aspect to benefit from this regime. Our aspirations for quality service know no limits and we have a constant stream of returning custom as testament to our relentless desire to provide the best service possible.



Knowledge

Every WTS design has a lifetime of knowledge behind it. All kits go out with full plant and wiring diagrams so the installer has full peace of mind when fitting the system. CAD is available if desired and for the larger more complex projects bespoke plant & wiring can be produced.

We have also a renowned expertise for integrated system & design with vast knowledge in balancing underfloor heating and radiator circuits and linking with renewables to provide super-efficient heating systems with miniscule running costs.

We have many glowing case studies available, including a stunning 5 star report from Heriot Watt University of one of our larger integrated systems, combining solar, ufh & pellet boilers

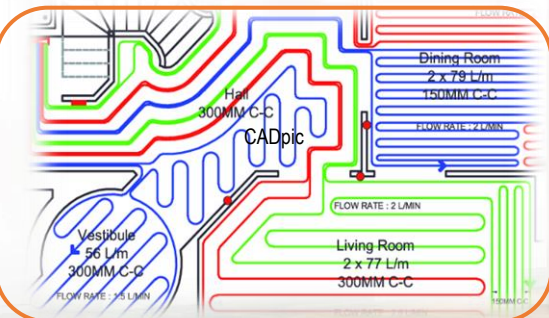

MANIFOLDS

Solid one piece nickel plated brass distribution manifolds with 3/4"EK take offs. They are supplied pre-assembled to suit the system required. The manifolds are supplied complete with isolation ball valves, fill/drain points, pressure gauges and mounting brackets. Also included are the nuts, rings and inserts for the pipe ordered.

Manifolds

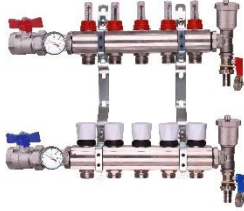
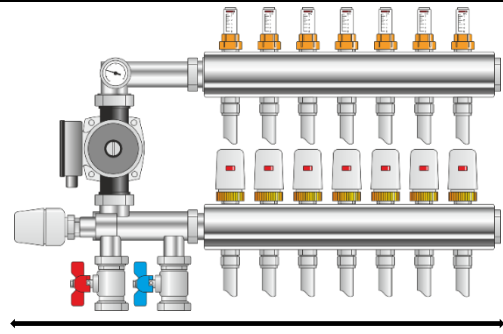
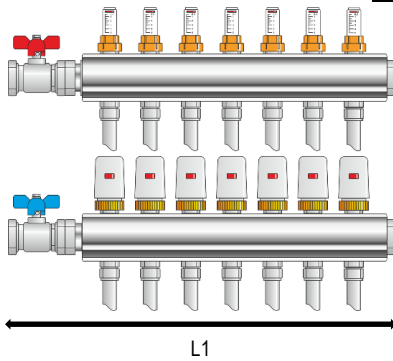

Image	Code	Description	List Price
	ZL-112502TK	1" manifold, with flow meters & temp gauge - 2 way	£81.48
	ZL-112503TK	1" manifold, with flow meters & temp gauge - 3 way	£94.20
	ZL-112504TK	1" manifold, with flow meters & temp gauge - 4 way	£108.39
	ZL-112505TK	1" manifold, with flow meters & temp gauge - 5 way	£130.62
	ZL-112506TK	1" manifold, with flow meters & temp gauge - 6 way	£145.26
	ZL-112507TK	1" manifold, with flow meters & temp gauge - 7 way	£166.97
	ZL-112508TK	1" manifold, with flow meters & temp gauge - 8 way	£181.69
	ZL-112509TK	1" manifold, with flow meters & temp gauge - 9 way	£203.37
	ZL-112510TK	1" manifold, with flow meters & temp gauge - 10 way	£218.04
	ZL-112511TK	1" manifold, with flow meters & temp gauge - 11 way	£238.84
	ZL-112512TK	1" manifold, with flow meters & temp gauge - 12 way	£259.61



	L1						L2					
Number of ports	2	3	4	5	6	7	8	9	10	11	12	
Manifold length (mm) L1	233	283	333	383	433	483	533	583	633	683	733	
Manifold length with thermostatic mixer unit (mm) L2	344	394	444	494	544	594	644	694	744	794	844	

MANIFOLD COUPLINGS

Nuts, rings and inserts for all our pipe sizes

Manifold Couplings

Image	Code	Description	List Price
	ZL-10391620	EK x 16/2 PEX/PERT fitting	1.25
	ZL-10391720	EK x 17/2 PEX/PERT fitting	1.25
	ZL-10391820	EK x 18/2 PEX/PERT fitting	1.25
	ZL-9178	Repair Coupler 3/4" x 3/4"	2.00

MANIFOLD ACCESSORIES

Spare parts and add-ons for our manifold range

Manifold Accessories

Image	Code	Description	List Price
	ZL-2811A	Auto Air Vent End Unit	9.75
	ZL-41308	3/4" Ball Valve Set for Blending Valve Red & Blue	10.50
	ZL-4167	1" ball valves f x f for zl-2546 (pair)	14.50
	ZL-9115	Manifold 3/4" Eurocone Blank	2.00

Pump Assemblies

PUMP/PUMP ASSEMBLIES
Thermostatic units and pumps for the WTS systems

Image	Code	Description	List Price
	ZL-2532	Single Zone Pump Mixer Set - No Pump	97.50
	ZL-2536	Multizone Pump Mixer Set - No Pump	97.50
	ZL-2545	Thermostatic Mixture System - no Pump	97.50
	711222563	Salus MP200A A-Rated Pump 6m Head	87.50

Pipe

PERT PIPE 16/2mm 5 layer with EVOH barrier
Our Standard UFH pipe

Image	Code	Description	List Price
	852170100	Pipelife 16/2 PERT 100m coil	75.40
	852170200	Pipelife 16/2 PERT 200m coil	150.80
	852170400	Pipelife 16/2 PERT 400m coil	301.60

ALPEX PIPE
WRAS approved, useful for UFH, offcuts can be used for plumbing

Image	Code	Description	List Price
	806170100	BZ PERT_AL-PERT pipe 16x2-85 m	74.38
	806170100	BZ PERT_AL-PERT pipe 16x2-100 m	87.50
	806170200	BZ PERT_AL-PERT pipe 16x2-200 m	175.00
	806170500	BZ PERT_AL-PERT pipe 16x2-300 m	262.50

Valves & Fittings

MOTORISED VALVES AND BLENDING VALVES
Spare parts and add-ons for our manifold range

Image	Code	Description	List Price
	ZL-2318	UFH Blending Valve - 22mm	45.00
	SBMV22	22mm 2 Port Zone Valve, 5 wire (with microswitch) 230v	62.50
	SBMV28	28mm 2 Port Zone Valve, 5 wire (with microswitch) 230v	67.50

ACTUATOR VALVES
Links with the roomstats via the wiring centre to provide individual loop control

	ZL-2033-230	Thermo-Electric Actuator 230V	15.00
	ZL-2033-24	Thermo-Electric Actuator 24V	15.00

STATS
Thermostatic control

Thermostatic Control

Image	Code	Description	List Price
	751105100	Salus HTRP 230V Programmable Thermostat	32.75
	751105200	Salus HTRP RF Programmable Thermostat	34.05
	751107100	Salus HTRS 230V Digital Thermostat	29.04
	75110720W	Salus Wireless Digital Roomstat - white	62.76
	751107300	Salus external sensor c/w 4m cable	13.13
	751200100	Salus RT100 Dial Thermostat	15.80
	751225004	Salus 4 Zone Hard wired Wiring Centre	35.70
	751225008	Salus 8 Zone Hard wired Wiring Centre	83.60
	751228004	Salus 4 Zone RF Wiring Centre	35.70
	751228008	Salus 8 Zone RF Wiring Centre	134.53
751600100	Salus Universal Connection Gateway	141.65	

FIXINGS
Used to secure the UFH pipe to floor

Fixings

Image	Code	Description	List Price
	ZL-CR01	U-Profiles-17mm - 1m lengths	1.17
	604005001	Plastic pipe clamp-60mm. (per 300)	20.30
	604005000	Plastic pipe clamp-40mm. (per 300)	23.43
	604004002	Hammer Clips (per 50) 16mm wide	8.61
	604004001	Wire ties per 1000 (any colour)	28.77

Accessories

Accessories

Image	Code	Description	List Price
	619141005	Hydratech Thermox DTX - 5 litres	24.86
	ZL-ES01	Edge strip with adhesive, 25m roll	25.90
	PA01	Pipe Cutter	7.80

WTS Single Zone Kits

SINGLE ZONE KITS
Entry level kits suitable for one zone only.

Our entry level Manhattan Systems are phenomenal value for money. They are perfect for a single zone/area and contain everything you need to have a fully functional floor heating system. We have even included a clockstat as standard to allow for full time and temperature control, something that's missing from the vast majority of other single zone systems (floor heating should be controlled completely independent of radiator circuits due to the different methods of operation). Also included is a fully comprehensive information booklet, covering all aspects of installation and operation. The price of our Manhattan Kits might be low but we haven't cut back on the quality. All the products are from leading manufacturers. In addition Warm The Sole only use high quality 3 layer PE-RT pipe with an oxygen barrier. This barrier prevents the entry of oxygen into the heating system via the pipework significantly reducing the risk of corrosion within the entire system.

Image	Code	Description	List Price
	MH10	Single Zone 10m ²	261.76
	MH15	Single Zone 15m ²	277.85
	MH20	Single Zone 20m ²	293.95
	MH25	Single Zone 25m ²	323.98
	MH30	Single Zone 30m ²	340.07
	This kit contains the following products. <ul style="list-style-type: none"> • 1 x single circuit mixing unit with pump and fittings • 60mm staples • 5 layer PE-RT Pipe with embedded oxygen diffusion barrier • 1 x Digital clockstat • pipe cutter • Delivery & installation/technical manual included 		

WTS Standard Kits

STANDARD MULTI ZONE KITS
Our most popular kits suitable for multiple rooms.

Warm The Sole heating systems are an excellent choice for those wishing to install a quality underfloor heating system in their property. The high quality components are sourced from some of the top names in underfloor heating system manufacturing and are matched to provide the optimal performance. It is worth noting that Warm The Sole Water Underfloor Heating kits feature water temperature control, this ensures that water flows through the heating system at the correct temperature: **beware of systems without this facility.** In addition Warm The Sole Standard Kits only use high quality PE-RT pipe with an embedded oxygen barrier. This barrier encases the inner layer of the PE-RT pipe completely, preventing the entry of oxygen into the heating system via the pipework. The tough outer layer is designed to withstand the rigors of surrounding workloads, ensuring that the oxygen barrier remains intact. This significantly reduces the risk of corrosion within the entire system. It is important to note that this system includes full time and temperature control for each room. Many other systems just offer a single roomstat no matter the size of the manifold. The Warm The Sole system allows for full thermostatic control in each room, ensuring your comfort throughout your property. The system is controlled overall via its own dedicated clockstat.

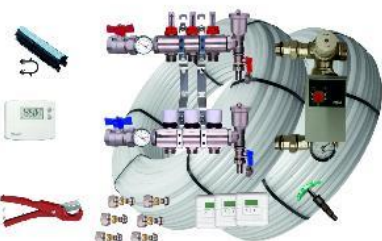
Image	Code	Description	List Price
	ST20	2 way manifold – 20m ²	£561.58
	ST40	2 way manifold – 40m ²	£680.68
	ST60	3 way manifold – 60m ²	£816.08
	ST80	4 way manifold – 80m ²	£925.53
	ST100	5 way manifold – 100m ²	£1,051.83
	ST120	6 way manifold – 120m ²	£1,161.70
	ST140	7 way manifold – 140m ²	£1,305.75
	ST160	8 way manifold – 160m ²	£1,415.70
	ST180	9 way manifold – 180m ²	£1,643.33
	ST200	10 way manifold – 200m ²	£1,753.23
	ST220	11 way manifold – 220m ²	£1,878.15
	ST240	12 way manifold – 240m ²	£1,993.93
A Warm the Sole Standard Underfloor Heating System – multi room includes: <ul style="list-style-type: none"> • 1 piece nickel plated brass manifold • Manifold pump/mixing valve unit • 5 layer PE-RT Pipe with embedded oxygen diffusion barrier • Wiring centres and actuators • Digital clockstat • Room thermostats • Edging insulation • Delivery & installation/technical manual Pipe staples, pipe cutters, nuts and olives, valves and all items required to install.			

SMART SYSTEM MULTI ZONE KITS

The top of the range system with many integrated extras

Our top of the range system has just about everything. It includes all you'd expect for a quality floor heating system - from 5 layer Pert pipe to 1" nickel plated brass manifolds.

The control system is what sets the package head and shoulders above the crowd though. We have made the system completely wireless – no need to crawl between walls to fit cabling. The setup also includes the Salus Smartsystem Gateway, allowing full control of the heating via your smartphone, just download the free app. This is just a small part of the iT600 SmartHome system, with the ability to control heating, appliances and monitor the security of your home.

Finally we have added in weather compensation to the whole package. Quite simply, there is no better value complete comfort heating system on the market.

The price is for the complete heating system including carriage

WTS Smart System Kits

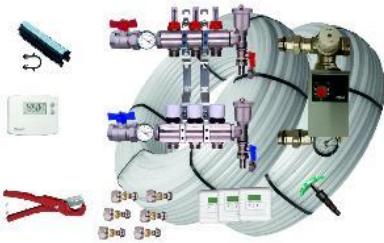

Image	Code	Description	List Price
	SM20	2 way manifold – 20m ²	£776.38
	SM40	2 way manifold – 40m ²	£890.80
	SM60	3 way manifold – 60m ²	£1,136.49
	SM80	4 way manifold – 80m ²	£1,311.65
	SM100	5 way manifold – 100m ²	£1,494.85
	SM120	6 way manifold – 120m ²	£1,650.16
	SM140	7 way manifold – 140m ²	£1,851.09
	SM160	8 way manifold – 160m ²	£2,026.78
	SM180	9 way manifold – 180m ²	£2,243.08
	SM200	10 way manifold – 200m ²	£2,418.72
	SM220	11 way manifold – 220m ²	£2,600.49
	SM240	12 way manifold – 240m ²	£2,761.93

A Warm the Sole Smart Underfloor Heating System – multi room includes:

- 1 piece nickel plated brass manifold
- Full weather compensation water temperature control
- 5 layer PE-RT Pipe with embedded oxygen diffusion barrier
- Wireless wiring centres and actuators
- Digital room thermostats with time and temperature control
- Edging insulation
- Pipe staples, pipe cutters, nuts and olives, valves and all items required to install.
- SG600 Internet Gateway
- Delivery & installation/technical manual included

It is important to note that this system includes full time and temperature control for each room. Many other systems just offer a single roomstat no matter the size of the manifold. The Warm The Sole system allows for full thermostatic control in each room, ensuring your comfort throughout your property. The system can be controlled overall via a smartphone.

ALL PRICES EX VAT

Warm The Sole Ltd
May Cottage
Lentran
Inverness
IV3 8RJ
01463 246600

www.warmthesole.co.uk
info@warmthesole.co.uk

underfloor heating | solar thermal | radiators | plumbing systems | biomass boilers